

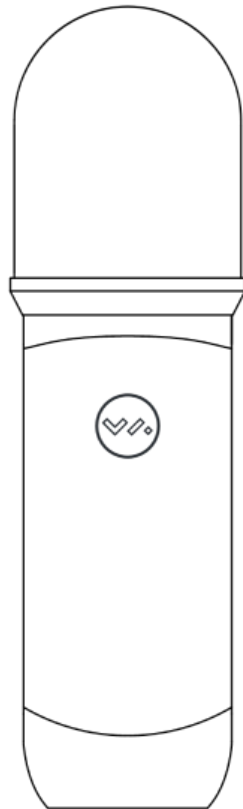

Spatial Mic Dante



User Guide
Version 1.5

Package Contents	3
Introduction	3
Requirements	4
Getting To Know Spatial Mic Dante	6
Mounting	6
Power Over Ethernet (PoE)	6
Outputs	7
Using Your Microphone	8
Positioning	8
Care & Maintenance	8
Thermal	8
Dante Setup	9
About Dante	9
Dante Controller	9
MicNet Control	10
Overview	10
Using MicNet Control	10
Software Installation	16
Spatial Mic Converter	17
Overview	17
Specifications	18
Warranty	20
Certifications	20
Support & Contact	22
Third Party Tools & Notices	23

Package Contents

- Spatial Mic Dante
- ¼-20 to ⅝” mini swivel ball hard-mount
- Foam windscreen
- For [Download](#):
 - Spatial Mic Converter VST3® plugin (Mac OSX & Windows), AU (Audio Unit for Mac OSX) and AAX (Windows & Mac OSX)
 - MicNet Control app (Mac OSX & Windows)
 - User Manual

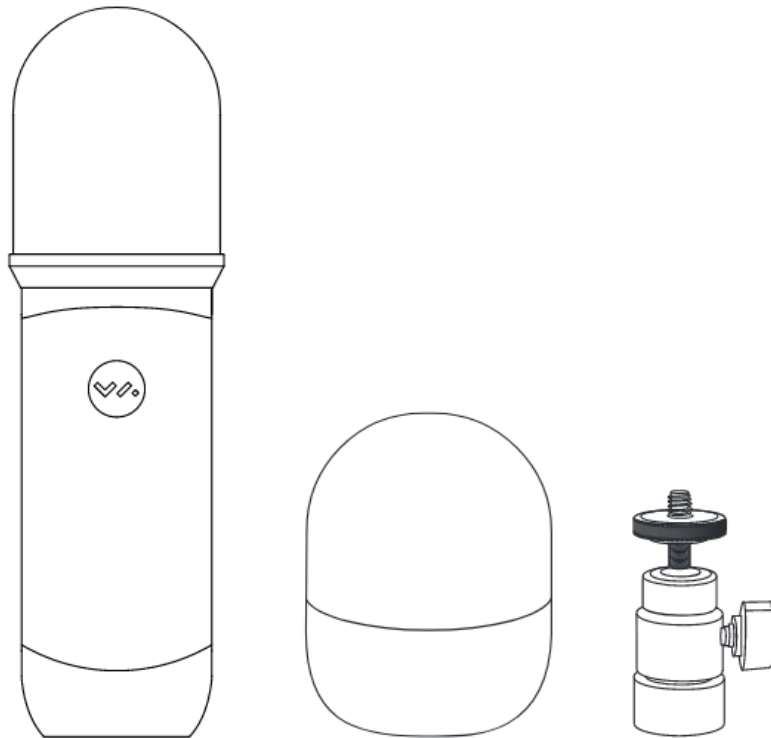

Introduction

Thank you for purchasing Spatial Mic Dante. With 8 capsules, Spatial Mic Dante precisely captures the entire soundfield while providing output flexibility for critical recording and live broadcast using built-in Dante audio networking. Using Voyage Audio's MicNet Control application, Spatial Mic Dante can directly output 1st order Ambisonics, 5.1, 5.1.2, or 7.1 surround sound, virtual mic stereo or mono pairs and the raw unprocessed audio from the

capsules. For the most flexibility and highest quality, the Spatial Mic Converter plugin can be used with the unprocessed audio from Spatial Mic to open up more output options like 2nd Order Ambisonics, 7.1.4 surround sound, and a wider variety of virtual mono/stereo microphone outputs including mid-side.

Spatial Mic captures the entire soundfield - letting you focus on recording immersive audio for VR, surround sound, spatial music, concert recording, live broadcasts and much more.

- Enhanced spatial resolution, pattern decoding, directivity & optimal listening area vs mics with fewer capsules
- Easy connectivity and routing using Dante™ audio networking
- Configurable output for surround sound, ambiX & virtual mics
- Dante audio network interface up to 32-bit / 192 kHz
- Capture quiet nature sounds or loud concerts with capsule SNR of up to 78dB-A and 136 dB Max SPL
- Individually calibrated for balanced array
- Professional quality analog to digital conversion, high resolution Skyworks clocking scheme and built-in 32-bit XMOS Processor
- DAW plugin (VST, AU, & AAX) and MicNet Control app for remote configuration

Streamlining the spatial audio workflow when dealing with multi-channel microphone arrays was a top priority during the development of Spatial Mic Dante. Dante audio networking utilizes standard IP networks to transmit high-quality, uncompressed audio with near-zero latency. It's the most economical, versatile, easy-to-use audio networking solution, and is scalable from simple installations to large-capacity networks running thousands of audio channels. With Dante audio networks routing audio is simple as a few mouse clicks.

Continuing with our tradition of single cable connected products, Dante replaces multiple analog or multicore cables with a single affordable Ethernet cable to transmit high-quality multi-channel audio safely and reliably. Dante is the audio networking choice of nearly all professional audio manufacturers. With thousands of Dante-enabled audio products available Spatial Mic Dante can be natively connected to a large and growing audio networking ecosystem.

We are excited for you to start working with Spatial Mic Dante. Please read this user manual and get to know everything this microphone package has to offer.

Requirements

- Power: Network switch or injector that provides Power over Ethernet (PoE) supporting IEEE 802.3af.
- Cat5e (or better) shielded Ethernet cable
- Managed Gigabit (1000 Mbps) or higher rated switches

- [Dante Controller](#) for routing the audio signal (available for free)
- [MicNet control and Spatial Mic Converter](#) plugin software installed on a computer
 - Spatial Mic Converter plugin and MicNet control have been tested to work on Apple Intel and M1 machines running Mac OSX 10.11 and higher or Windows 10
 - Spatial Mic Dante can also work stand alone and will recall the last saved settings
- For recording, a DAW supporting multi-channel audio tracks like [Reaper](#), [Pro Tools Studio](#), [Pro Tools Flex](#), [Logic Pro](#) or [Nuendo](#)

Getting To Know Spatial Mic Dante

Mounting

A ¼-20 thread mount on the back of the mic allows for a multitude of mounting options. The included mount enables mounting to a standard microphone stand.

1. Screw the included ¼-20 to 5/8" mini swivel ball hard-mount into the ¼-20 threads on the back of Spatial Mic.
2. Screw the bottom of the mount into a microphone stand.
3. Use the ball mount to adjust the angle of the microphone.

Note: This method does not provide acoustic isolation from the mic stand.

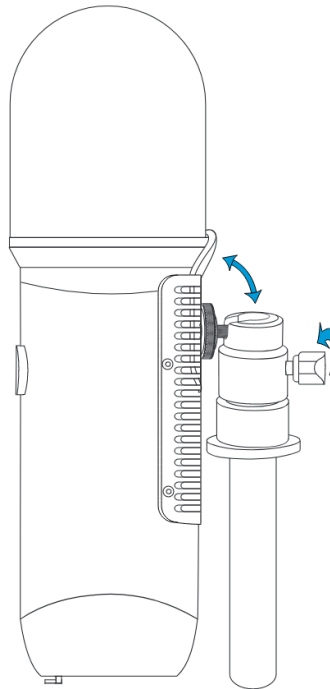

For acoustic isolation, use a [Rycote InVision shockmount](#) (sold separately). Place Spatial Mic Dante in the shockmount so that the mounting screws do not come in contact with the heat sink. Ensure the microphone cannot slip out of shockmount.

Power Over Ethernet (PoE)

This device requires Power Over Ethernet (PoE) to operate and is compatible with IEEE 802.3af Class 0 power sourcing equipment that uses Alternative A (power on data pair) or Alternative B

(power on spare pair) options. Power over Ethernet is most commonly delivered by a network switch or injector.

To power the mic simply plug a PoE compatible CAT5E or better shielded Ethernet cable into the microphone and the other end into a switch or injector. After a moment, the lights on the bottom of the mic should become active indicating the microphone is receiving power.

Outputs

Use the locking RJ45 etherCON jack on the bottom of Spatial Mic Dante to connect a Cat5e (or better) shielded Ethernet cable for single wire connectivity to a Dante™ audio network or AES67 RTP network.

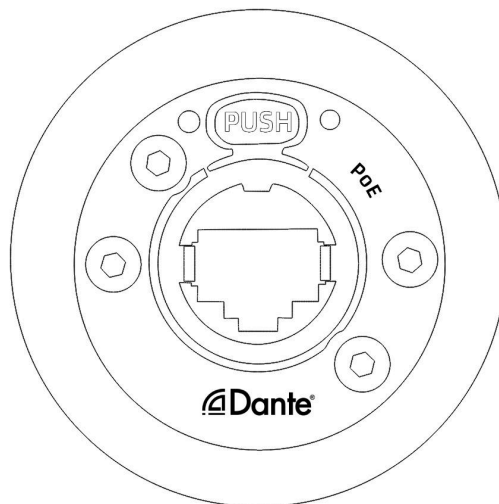

Using Your Microphone

Positioning

The VA badge on Spatial Mic Dante indicates the front or 'zero' degree position. This corresponds to the direction the 'head' image is facing in Spatial Mic Converter Plugin when in its default state. When recording audio for 360 video, you will probably want to orient the front of the microphone to correspond to the front of the camera (normal orientation), but please note that the Spatial Mic Converter plugin 'orientation' button can change the orientation of the mic after recording to be 'end-fire' or 'inverted'.

Care & Maintenance

- Spatial Mic features robust mechanical, however you should always try to handle the microphone carefully and avoid dropping or sudden shocks.
- Clean microphone body with a clean, dry cloth. With the headbasket detached, you may clean both sides with a slightly damp cloth and re-attach when dry.
- Keep working distance at least 6 inches from the microphone.
- Avoid leaving Spatial Mic in extreme temperatures, humidity or direct sunlight for extended periods of time.
- Use the included windscreen to protect the capsule array from wind and moisture as needed.
- Do not over-bend cables as this may cause them to break or become intermittent.
- Spatial Mic Dante is factory calibrated before shipping

Thermal

Like many network devices, Spatial Mic Dante generates heat and is cooled by natural convection using an aluminum heat sink. Keep Spatial Mic Dante in open air and do not enclose the mic in small spaces while in operation. It is recommended to not touch the heat sink during operation.

The maximum temperature of the operating environment should not exceed 45 degrees Celsius.

It is recommended to power down Spatial Mic when not in use and keep away from prolonged exposure to direct Sun.

Dante Setup

About Dante

Developed by Audinate, Dante enables digital audio distribution over standard Ethernet networks. Dante allows audio, control, and all other data to coexist on the same network in an ultra-low latency environment and with near-perfect synchronization. The Dante Controller software and network management features make even the most complex network configuration quick and easy.

Dante Controller

Dante Controller is a software application provided by Audinate which allows users to configure and route audio and video around Dante networks. All settings such as clock, sample rate, routing, streams and, etc. are all done within the Dante Controller. Dante Controller is free software available for Windows and Mac, and can be downloaded on [Audinate's Website](#).

Dante Controller offers automatic device discovery, one-click signal routing, device status information, real-time network monitoring including device-level latency and customized event logging. At startup Dante Controller scans the network for connected Dante devices and shows them automatically in the Network View.

User guides, FAQs, technical documentation, and more about Dante and the Dante Controller software is available at <https://www.audinate.com/support>

MicNet Control

Overview

The MicNet Control application enables users to monitor and adjust the output settings of Spatial Mic Dante from a computer connected to the same network as the microphone. Note that MicNet Control does not process audio itself - it controls the audio processing within a connected microphone. The microphone's output can be changed between raw unprocessed audio, 1st order Ambisonics, surround sound, and virtual mic stereo or mono pairs. MicNet also includes mic gain control, level metering, mic orientation, mute, network status, as well as sample rate and bit depth information.

MicNet Control communicates with the microphone through the same Ethernet cable used to supply PoE and stream audio data over the network. After configuring Spatial Mic Dante with MicNet control you can stream or record over a Dante™ audio network or AES67 RTP network.

Features

- Adjust multiple Spatial Mics from a single application
- Configure the internal microphone DSP to transform the array output for streaming or recording directly from the mic
- Output formats:
 - Unprocessed (raw audio signals that will later be transformed with the Spatial Mic Converter plugin)
 - 1st order Ambisonics in ambiX format
 - 5.1, 5.1.2, or 7.1 surround
 - First order virtual mic pattern decoding: cardioid through figure-8 (mono) and stereo X/Y to Blumlein (crossed fig-8)
- Mic gain control, orientation correction and mute controls
- Level meters with clip indication of audio on the Dante network
- Network status indication
- ID Spatial Mic visually (flashes the gigabit and network active LEDs on bottom of mic)
- Lock the output selection to guard against unwanted changes during a performance

Using MicNet Control

Launch MicNet Control from a computer connected to the same Dante™ audio network as the microphone you want to control.

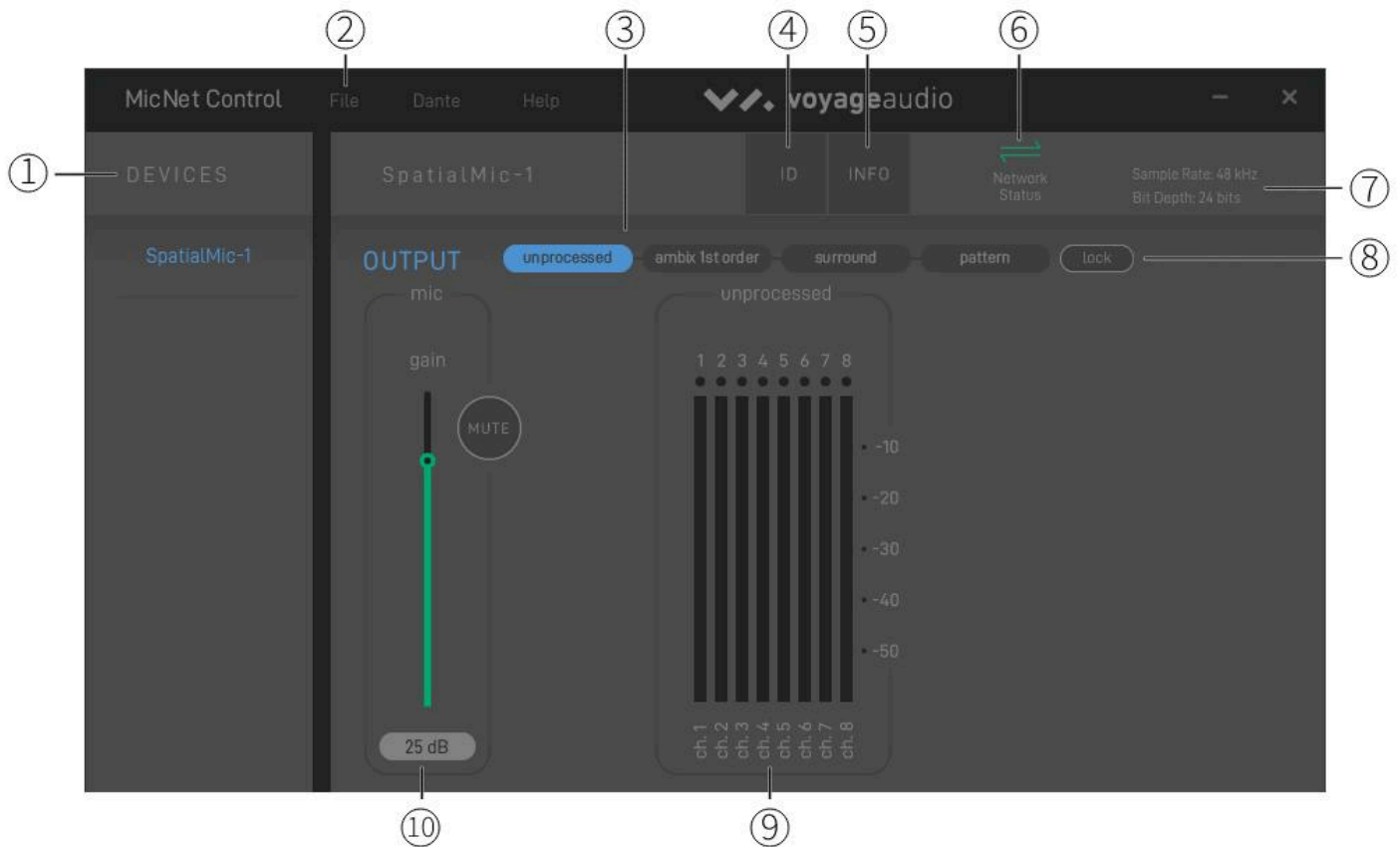

1. Devices

Each Spatial Mic Dante on the network will be displayed in the device list. Click on the device name to view and make changes to the Spatial Mic output settings. The device name can be changed in the Dante Controller app.

2. Menu

a. File

- Refresh the device list.
- Save current settings to the device.
 1. Gain changes, output selection and output settings will be saved to the currently selected Spatial Mic. These settings are recalled when Spatial Mic Dante is power cycled.
- Reset the device to default settings.
- Update device firmware.
- Log of events.
- Quit the application.

- b. Dante
 - Launch Dante Controller.
- c. Help
 - About MicNet.
 - Link to this manual.

3. Output

Select one of four different output options.

Note: When Spatial Mic's sample rate is set above 48kHz the output can only be uncompressed audio and will switch automatically. The other output options will not be visible in the MicNet GUI until the sample rate is adjusted back to 48kHz or below. The sample rate for Spatial Mic is adjusted using Dante Controller.

- **Unprocessed Audio**
 - Outputs each of the eight individual microphone capsule signals on its own channel to be processed later using the [Spatial Mic Converter Plugin](#).
- **Ambix 1st Order**
 - Output 1st Order Ambisonics in Ambix format for use in live immersive sound mixing, broadcast or streaming applications.
- **Surround Sound**
 - Output 5.1, 5.1.2, or 7.1 surround sound for live immersive sound mixing, broadcast or streaming applications
- **Pattern**
 - Decode the mic array into configurable polar patterns for mono and stereo output

4. ID

Clicking on the ID button will flash the LEDs on the bottom of Spatial Mic Dante selected to help identify the physical location of the mic.

5. Info

Selecting info will display the device Name, Model #, IP address, Mac address, Clock info and more. The info is not editable in this window but it can be adjusted in the Dante Controller application.

6. Network Status

MicNet can communicate with Voyage Audio devices on the primary network, or the secondary network, or both. MicNet needs to know which of the host computer's network interfaces are connected to each physical Dante network.

To select the network interface that MicNet will use to communicate with Voyage Audio Dante Products on the Dante network click on the two arrows above Network Status.

The window shown below will open and you can select the primary (Interface1) and secondary (Interface2) Network interfaces for Dante.

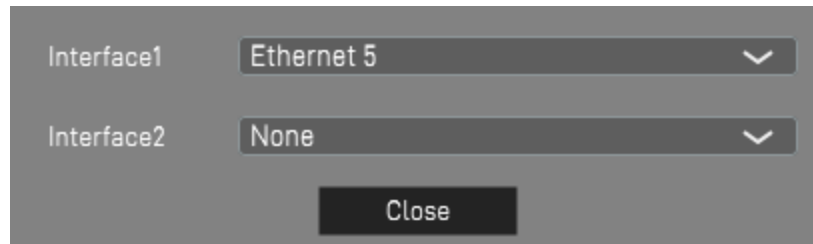

↔ The network status icon will be green if there is a network connection present and synced.

↔ The icon will be red if there is a network and there is a connection issue or if there is no network detected.

7. Sample Rate and Bit Depth

Displays the device's sample rate and bit depth. These settings can be changed in the Dante Controller application.

- Sample rate: 44.1kHz, 48kHz, 88.2kHz, 96kHz, 176.4kHz, 192kHz
- Bit Depth: 16bit, 24bit, 32bit

8. Lock

Lock the output to avoid accidentally switching the output during a recording or live broadcast. **Note:** The parameters for the selected output setting are still adjustable.

9. Output Controls

Each output option has its own set of controls.

a. Unprocessed Audio

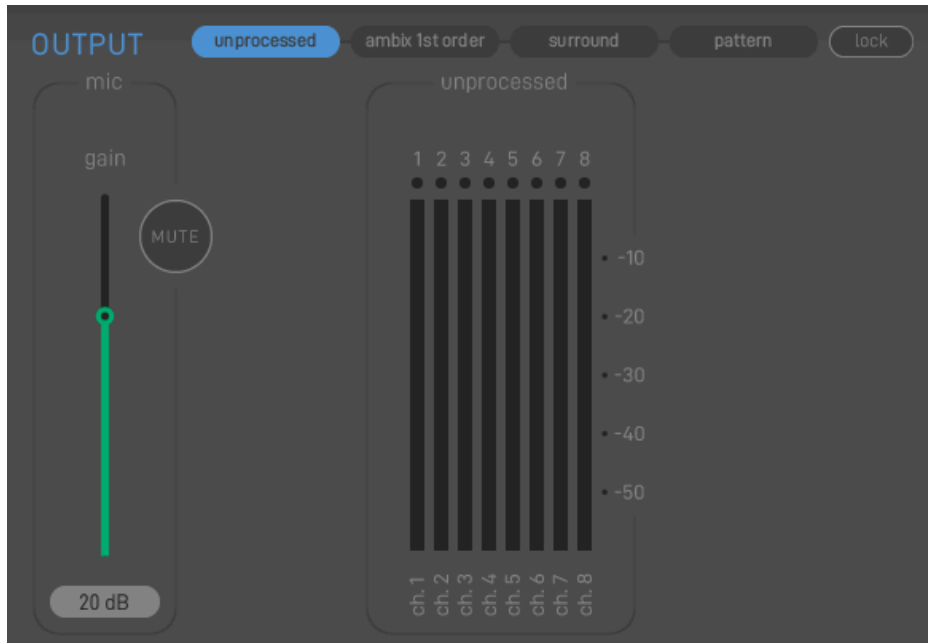

- There are no additional controls for this setting, only output meters with clip indicators.

b. Ambix 1st Order

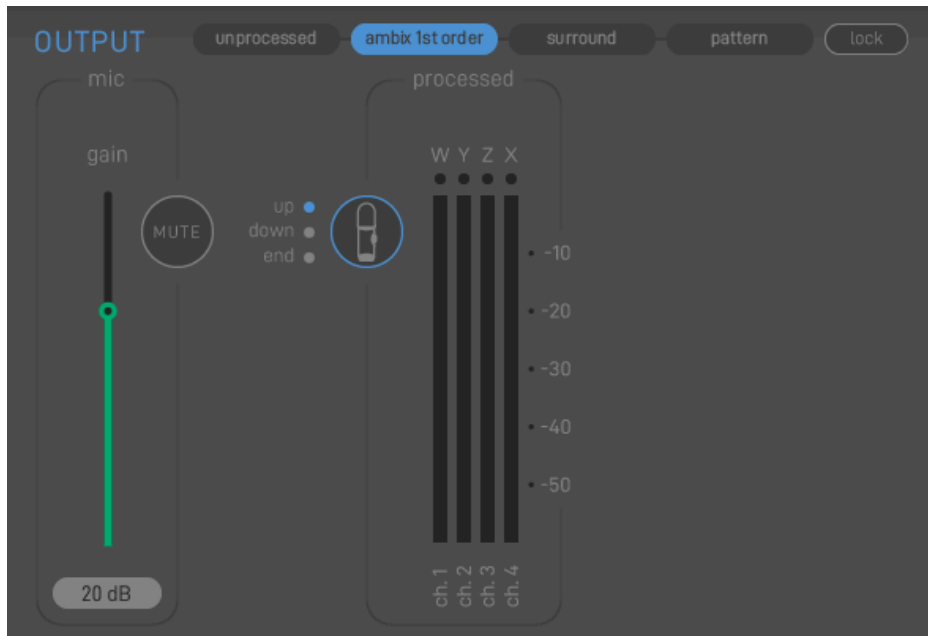

- The orientation of the microphone can be selected for correcting endfire and upside down mounting.
- Output meters with clip indicators.
- The channel names are indicated above the meters to help with routing.

c. Surround

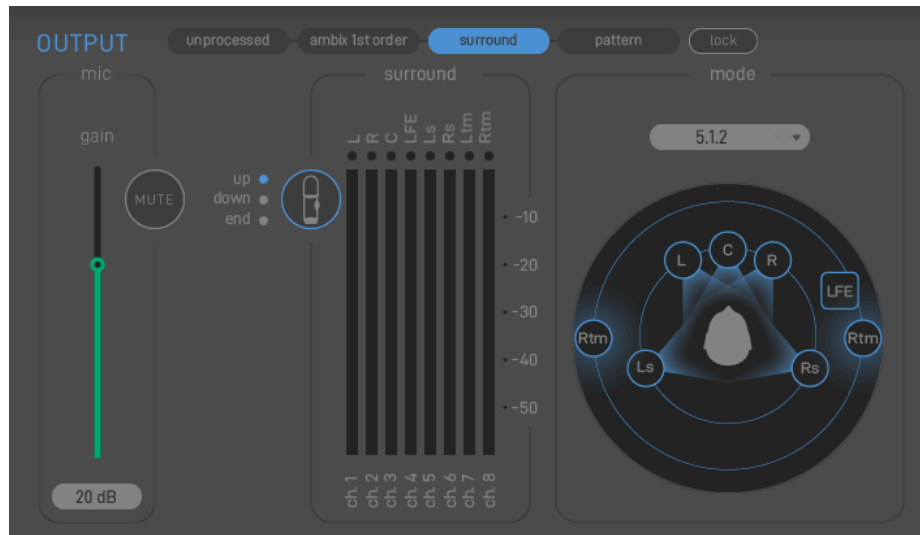

- Mode options for 5.1, 5.1.2, and 7.1 surround sound.
- The orientation of the microphone can be selected for correcting endfire and upside down mounting.
- Output meters with clip indicators.
- The channel names are indicated above the meters to help with routing. These names change based on the surround mode selected.
- The LFE channel is derived from a low pass of the W channel and is attenuated to conform with LFE level standards.

d. Pattern

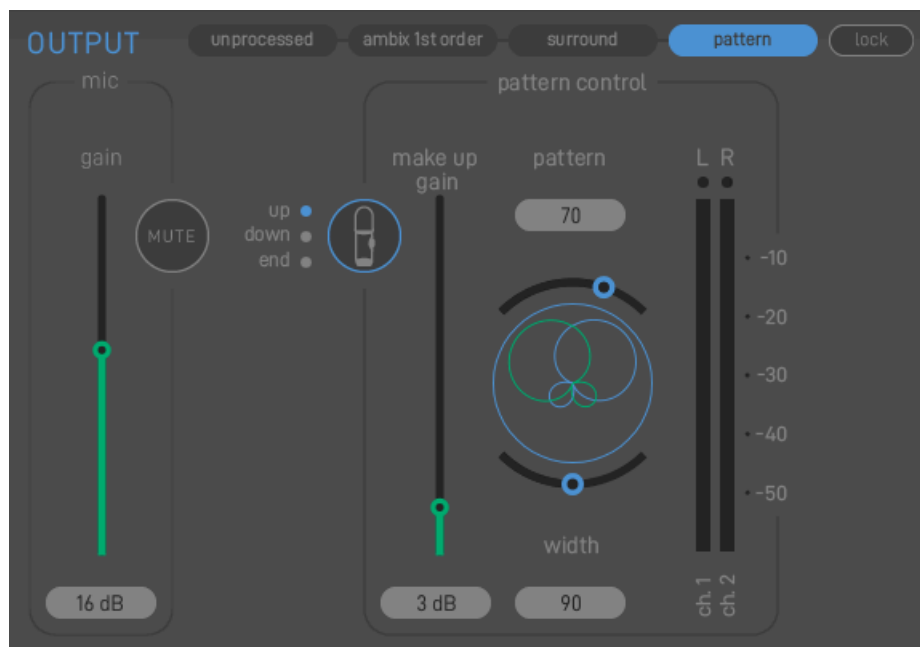

- The pattern control section outputs two channels of audio. If the width is set to 0° the output is two mono channels of the selected polar pattern. As the width is increased the angle between the two polar patterns is increased creating a stereo output.
- The orientation of the microphone can be selected for correcting endfire and upside down mounting.
- Make up gain control to optimize the signal output after the polar pattern decoding process.
- Continuously variable polar patterns from Omni to Cardioid to Figure Eight.
- Adjustable width for creating a stereo output of common stereo mic techniques such as X/Y coincident pair or Blumlein.
- Output meters with clip indicators.

10. Mic

The mic gain and mic mute simultaneously controls all eight analog microphone preamps inside of Spatial Mic Dante prior to Analog to Digital Conversion.

Software Installation

The installer for the MicNet software can be downloaded at <https://voyage.audio/downloads/>

1. Unzip the downloaded file and run the installation program.
2. Follow the instructions in the installer to complete the installation.
3. If required, to uninstall, manually delete the files from your computer.

MicNet Change Log

1.0.0

- Initial Release

1.0.8

- Added Network Server Interface selection options
- Installer now includes third-party redistributable applications for the network server interface
- Performance Optimization

Spatial Mic Converter



Overview

The Spatial Mic Converter plugin transforms the unprocessed audio signals from Spatial Mic Dante to a format useful for audio production. While some format conversions can be performed directly in the microphone and selected as an output using MicNet, using the Spatial Mic Converter plugin utilizes a higher quality conversion and allows more flexibility with a larger array of output options including 2nd order ambisonics and up to 7.1.4 surround sound. To accomplish this, Spatial Mic Converter uses an internal 64-channel filter matrix and measurements from an anechoic chamber.

Spatial Mic Converter offers the capability to change the microphone's aim at the point in space where the audio was recorded. This is useful when aligning audio position with 360 video, aiming the mic at specific sounds that should be in front of the listener, or used in combination with the virtual mic output stage to focus directional polar patterns at different parts of the soundfield.

The audio output from Spatial Mic Converter can be first or second order ambisonics in AmbiX or Fuma, as mono or stereo virtual mics, or up to 7.1.4 surround. The ambisonic output can be sent to a variety of plugins from [SSA](#), [Blue Ripple Sound](#), [IEM](#), [SPARTA](#) and others for further processing while mono or stereo virtual mic outputs can be used with standard audio production plugins. The surround sound outputs can be used directly in your surround mixes or as the bed tracks in a Dolby Atmos® session.

To download the Spatial Mic Converter plugin and the full manual for Spatial Mic Converter please visit <https://voyage.audio/downloads>.

Specifications

- Electrical:

- Up to 8 channels streaming over standard IP network
- Output mode streaming channel count over network:

Unprocessed (to be processed by Spatial Mic Converter plugin)	8 Channels
5.1 Surround	6 Channels
5.1.2 Surround	8 Channels
7.1 Surround	8 Channels
Virtual Mic Pattern Decode	2 Channels

- Neutrik NE8FBH-C5 locking etherCON, also compatible with standard RJ45 connectors
- Digital performance over Dante network: 44.1 kHz, 48 kHz, 88.2 kHz, 96 kHz, 176.4 kHz and 192 kHz (-4% / -0.1% / +0.1% / +4.167%) up to 32-bit
- AES67 mode at 48 kHz / 32-bit
- DSP: 32-bit XMOS with 16 real-time logical cores
- DSP Output Modes: Unprocessed up to 192 kHz, all other decoding modes up to 48 kHz
- Clock source: Internal or from Dante network primary
- ADC: 114-dB per channel at 24-bits
- Power: Complies with IEEE 802.3af PoE Class 0 power sourcing equipment that uses Alternative A or Alternative B options
- Power consumption: 4.8W max
- Thermal: Operates at up to an ambient temperature of 45 degrees Celsius
- Spatial Mic Converter plugin DSP filter type: 64-element output filter matrix

- Individual calibration stored in each Mic for a balanced array
- Capsule & Array:
 - 14.6mm Prepolarized Condenser
 - SNR: 78dB-A at 1 kHz
 - Frequency Response: 20Hz to 20kHz
 - Sensitivity: -42dB +/- 3dB @1kHz
 - Max SPL: <3% THD 136dB at 1 kHz
 - Array: 8 transducers¹
 - Array Ordering: Looking at Spatial Mic Dante from the front, as indicated by the VA badge, Capsule 1 is on the lower right (Roman numeral 'I'). Capsule 5 is on the top ring of the capsule array and inline with the VA logo. The bottom ring contains capsule 1-4 and the top ring contains capsule 5-8.
- Mechanical:
 - Construction: Aluminum & Nylon
 - Spatial Mic Dante Dimensions: Height: 7.65 in (19.4cm) Diameter: 2.25 in (5.7cm)
 - Weight (Mic only): 0.86lbs
- System Requirements
 - Host computer running Dante Controller for signal routing
 - Host computer running MicNet Control app for device control (device can be used without MicNet Control and will recall the last saved settings upon power up)
 - PoE from a switch or separate PoE injector supporting IEEE 802.3af
 - Managed Gigabit (1000 Mbps) or higher rated switches
- Included Accessories:
 - ¼-20 to ⅝” mini swivel ball hard-mount
 - Foam windscreen
 - For [Download](#):
 - Spatial Mic Converter plugin installer for OSX & Windows including: VST3[®] plugin (Mac OSX & Windows), AU (Audio Unit for Mac OSX) and AAX (Windows & Mac OSX)
 - MicNet Control app (Mac OSX & Windows)
 - User Manual
- Optional Accessories:
 - Rycote InVision shockmount

¹ [Based on geometry presented at the 133 AES Convention](#)

Warranty

Voyage Audio guarantees all products against manufacturing defects within one (1) year from the date of purchase. The warranty only applies to Voyage Audio products purchased from Voyage Audio directly or authorized dealers. Warranty claims require a copy of the original proof of purchase from Voyage Audio or authorized dealer. If a product requires service during this time period, please contact Voyage Audio via our email address to discuss & troubleshoot the problem. Voyage Audio will not accept repair or returned items for any reason without prior approval. Please contact Voyage Audio for a return authorization number. The RA number must be clearly marked on the returned package. If needed, we will repair or replace the product at no charge to you. At our discretion, this may include either repair with new or refurbished parts, replacement with a new or refurbished product or a refund for the purchase price, less shipping. Products that have been replaced or repaired are covered under the remaining warranty for the original product. or sixty (60) days from the date of repair or replacement, whichever is longer.

Please be advised that this warranty does not cover damage caused by accident, acts of nature, abuse, misuse or failure to use the product as instructed or implied by the user manual. In addition, this warranty does not cover any alteration or repair by anyone other than Voyage Audio or an authorized third-party. The warranty does not cover scratches, dents or other cosmetic damage, nor does it cover damage to other accessories or gear used in conjunction with Voyage Audio products. Due to the nature of audio recording and production, Voyage Audio cannot guarantee product operation with all end user equipment. Voyage Audio cannot be held liable to you or anyone else for any loss of use, data, profits or any damages whatsoever.

This warranty is non-transferable and applies only to the original owner.

If you would like calibration or service performed on a product that is not covered under warranty, please contact Voyage Audio.

Voyage Audio is not responsible for shipping charges related to warranty, calibration or service.

Certifications

This device complies with part 15 of the FCC Rules. Operation is subject to the following two conditions:

1. This device may not cause harmful interference.
2. This device must accept any interference received, including interference that may cause undesired operation.

Note: This equipment has been tested and found to comply with the limits for a Class B digital device, pursuant to part 15 of the FCC Rules. These limits are designed to provide reasonable protection against harmful interference in a residential installation. This equipment generates uses and can radiate radio frequency energy and, if not installed and used in accordance with the instructions, may cause harmful interference to radio communications. However, there is no guarantee that interference will not occur in a particular installation. If this equipment does cause harmful interference to radio or television reception, which can be determined by turning the equipment off and on, the user is encouraged to try to correct the interference by one or more of the following measures:

- Reorient or relocate the receiving antenna.
- Increase the separation between the equipment and the receiver.
- Connect the equipment to an outlet on a circuit different from that to which the receiver is connected.
- Consult the dealer or an experienced radio/TV technician for help.

Industry Canada ICES-003 Compliance Label: CAN ICES-3 (B)/NMB-3(B)

Note: Testing is based on the use of recommended cable types.

Support & Contact

Website:

<https://voyage.audio>

E-mail:

info@voyage.audio

Address:

Voyage Audio LLC.
3555 Rosecrans St. Suite #114-491
San Diego, CA 92110 USA

Third Party Tools & Notices



Intel MKL Library - Intel Simplified Software License (Version April 2018)

Copyright (c) 2018 Intel Corporation.

Use and Redistribution. You may use and redistribute the software (the “Software”), without modification, provided the following conditions are met:

- * Redistributions must reproduce the above copyright notice and the following terms of use in the Software and in the documentation and/or other materials provided with the distribution.
- * Neither the name of Intel nor the names of its suppliers may be used to endorse or promote products derived from this Software without specific prior written permission.
- * No reverse engineering, decompilation, or disassembly of this Software is permitted.

Limited patent license. Intel grants you a world-wide, royalty-free, non-exclusive license under patents it now or hereafter owns or controls to make, have made, use, import, offer to sell and sell (“Utilize”) this Software, but solely to the extent that any such patent is necessary to Utilize the Software alone. The patent license shall not apply to any combinations which include this software. No hardware per se is licensed hereunder.

Third party and other Intel programs. “Third Party Programs” are the files listed in the “third-party-programs.txt” text file that is included with the Software and may include Intel programs under separate license terms. Third Party Programs, even if included with the distribution of the Materials, are governed by separate license terms and those license terms solely govern your use of those programs.

DISCLAIMER. THIS SOFTWARE IS PROVIDED "AS IS" AND ANY EXPRESS OR IMPLIED WARRANTIES, INCLUDING, BUT NOT LIMITED TO, THE IMPLIED WARRANTIES OF MERCHANTABILITY, FITNESS FOR A PARTICULAR PURPOSE, AND NON-INFRINGEMENT ARE DISCLAIMED. THIS SOFTWARE IS NOT INTENDED FOR USE IN SYSTEMS OR APPLICATIONS WHERE FAILURE OF THE SOFTWARE MAY CAUSE PERSONAL INJURY OR DEATH AND YOU AGREE THAT YOU ARE FULLY RESPONSIBLE FOR ANY CLAIMS, COSTS, DAMAGES, EXPENSES, AND ATTORNEYS' FEES ARISING OUT OF ANY SUCH USE, EVEN IF ANY CLAIM ALLEGES THAT INTEL WAS NEGLIGENT REGARDING THE DESIGN OR MANUFACTURE OF THE MATERIALS.

LIMITATION OF LIABILITY. IN NO EVENT WILL INTEL BE LIABLE FOR ANY DIRECT, INDIRECT, INCIDENTAL, SPECIAL, EXEMPLARY, OR CONSEQUENTIAL DAMAGES (INCLUDING, BUT NOT LIMITED TO, PROCUREMENT OF SUBSTITUTE GOODS OR SERVICES; LOSS OF USE, DATA, OR PROFITS; OR BUSINESS INTERRUPTION) HOWEVER CAUSED AND ON ANY THEORY OF LIABILITY, WHETHER IN CONTRACT, STRICT LIABILITY, OR TORT (INCLUDING NEGLIGENCE OR OTHERWISE) ARISING IN ANY WAY OUT OF THE USE OF THIS SOFTWARE, EVEN IF ADVISED OF THE POSSIBILITY OF SUCH DAMAGE. YOU AGREE TO INDEMNIFY AND HOLD INTEL HARMLESS AGAINST ANY CLAIMS AND EXPENSES RESULTING FROM YOUR USE OR UNAUTHORIZED USE OF THE SOFTWARE.

No support. Intel may make changes to the Software, at any time without notice, and is not obligated to support, update or provide training for the Software.

Termination. Intel may terminate your right to use the Software in the event of your breach of this Agreement and you fail to cure the breach within a reasonable period of time.

Feedback. Should you provide Intel with comments, modifications, corrections, enhancements or other input (“Feedback”) related to the Software Intel will be free to use, disclose, reproduce, license or otherwise distribute or exploit the Feedback in its sole discretion without any obligations or restrictions of any kind, including without limitation, intellectual property rights or licensing obligations.

Compliance with laws. You agree to comply with all relevant laws and regulations governing your use, transfer, import or export (or prohibition thereof) of the Software.

Governing law. All disputes will be governed by the laws of the United States of America and the State of Delaware without reference to conflict of law principles and subject to the exclusive jurisdiction of the state or federal courts sitting in the State of Delaware, and each party agrees that it submits to the personal jurisdiction and venue of those courts and waives any objections. The United Nations Convention on Contracts for the International Sale of Goods (1980) is specifically excluded and will not apply to the Software.

*Other names and brands may be claimed as the property of others.

Dolby Atmos® is a registered trademark of Dolby Laboratories.

Dante® and Audinate™ are registered trademarks of Audinate Pty Ltd.